



Self-Contained Audio Preamplifier

Preliminary Technical Data

SSM2019

FEATURES

- Excellent Noise Performance: $950 \text{ pV}/\sqrt{\text{Hz}}$ or 1.5 dB Noise Figure
- Ultralow THD: $< 0.01\%$ @ $G = 100$ Over the Full Audio Band
- Wide Bandwidth: 1 MHz @ $G = 100$
- High Slew Rate: 20 V/us (Typical)
- Unity Gain Stable
- True Differential Inputs
- Subaudio 1/f Noise Corner
- 8-Pin Mini-DIP or 16-Pin SOIC
- Only One External Component Required
- Very Low Cost
- Extended Temperature Range: -40°C to $+85^\circ\text{C}$

APPLICATIONS

- Audio Mix Consoles
- Intercom/Paging Systems
- Two-Way Radio
- Sonar
- Digital Audio Systems

FUNCTIONAL BLOCK DIAGRAM

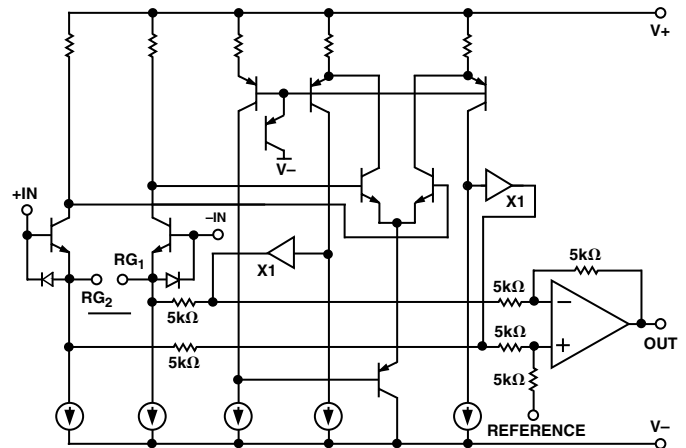

GENERAL DESCRIPTION

The SSM2019 is a latest generation audio preamplifier, combining SSM preamplifier design expertise with advanced processing. The result is excellent audio performance from a monolithic device, requiring only one external gain set resistor or potentiometer. The SSM2019 is further enhanced by its unity gain stability.

Key specifications include ultralow noise (1.5 dB noise figure) and THD ($< 0.01\%$ at $G = 100$), complemented by wide bandwidth and high slew rate.

Applications for this low-cost device include microphone preamplifiers and bus summing amplifiers in professional and consumer audio equipment, sonar, and other applications requiring a low noise instrumentation amplifier with high gain capability.

PIN CONNECTIONS

- 8-Pin PDIP (N Suffix)
- 8-Pin Narrow Body SOIC (RN Suffix)*

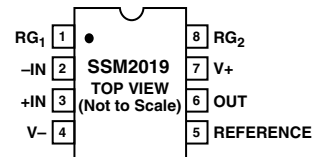

- 16-Pin Wide Body SOIC (RW Suffix)

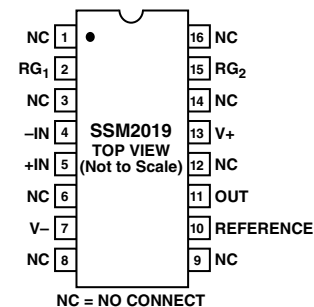

*For informational purposes only. Marketing should be contacted regarding this package.

REV. PrE 8/30/2002

Information furnished by Analog Devices is believed to be accurate and reliable. However, no responsibility is assumed by Analog Devices for its use, nor for any infringements of patents or other rights of third parties that may result from its use. No license is granted by implication or otherwise under any patent or patent rights of Analog Devices.

One Technology Way, P.O. Box 9106, Norwood, MA 02062-9106, U.S.A.
 Tel: 781/329-4700 www.analog.com
 Fax: 781/326-8703 © Analog Devices, Inc., 2002

PRELIMINARY TECHNICAL DATA

SSM2019—SPECIFICATIONS ($V_S = \pm 15\text{ V}$ and $-40^\circ\text{C} < T_A < +85^\circ\text{C}$, unless otherwise noted. Typical specifications apply at $T_A = 25^\circ\text{C}$.)

Parameter	Symbol	Conditions	Min	Typ	Max	Unit
DISTORTION PERFORMANCE						
Total Harmonic Distortion Plus Noise	THD+N	$T_A = 25^\circ\text{C}$ $V_O = 7\text{ V rms}$ $R_L = 2\text{ k}\Omega$ $G = 1000, f = 1\text{ kHz}$ $G = 100, f = 1\text{ kHz}$ $G = 10, f = 1\text{ kHz}$ $G = 1, f = 1\text{ kHz}$		0.012 0.005 0.004 0.008		% % % %
NOISE PERFORMANCE						
Input Referred Voltage Noise Density	e_n	$f = 1\text{ kHz}, G = 1000$ $f = 1\text{ kHz}; G = 100$ $f = 1\text{ kHz}; G = 10$ $f = 1\text{ kHz}; G = 1$		0.95 1.7 8 50		$\text{nV}/\sqrt{\text{Hz}}$ $\text{nV}/\sqrt{\text{Hz}}$ $\text{nV}/\sqrt{\text{Hz}}$ $\text{nV}/\sqrt{\text{Hz}}$
Input Current Noise Density	i_n	$f = 1\text{ kHz}, G = 1000$		2		$\text{pA}/\sqrt{\text{Hz}}$
DYNAMIC RESPONSE						
Slew Rate	SR	$G = 10$ $R_L = \text{TBD k}\Omega$ $C_L = 100\text{ pF}$ $T_A = 25^\circ\text{C}$		20		$\text{V}/\mu\text{s}$
Small Signal Bandwidth	$\text{BW}_{-3\text{ dB}}$	$G = 1000$ $G = 100$ $G = 10$ $G = 1$		TBD TBD TBD TBD		kHz kHz kHz kHz
INPUT						
Input Offset Voltage	V_{IOS}			0.1	0.25	mV
Input Bias Current	I_B	$V_{\text{CM}} = 0\text{ V}$		6	15	μA
Input Offset Current	I_{OS}	$V_{\text{CM}} = 0\text{ V}$		± 0.002	± 2.5	μA
Common-Mode Rejection	CMR	$V_{\text{CM}} = \pm 12\text{ V}$ $G = 1000$ $G = 100$ $G = 10$ $G = 1, T_A = 25^\circ\text{C}$ $G = 1, T_A = -40^\circ\text{C to } +85^\circ\text{C}$	80 60 40 26 20	112 92 74 54 54		dB dB dB dB dB
Power Supply Rejection	PSR	$V_S = \pm 5\text{ V to } \pm 18\text{ V}$ $G = 1000$ $G = 100$ $G = 10$ $G = 1$	80 60 40 26	124 118 101 82		dB dB dB dB
Input Voltage Range	IVR		± 12			V
Input Resistance	R_{IN}	Differential, $G = 1000$ $G = 1$ Common Mode, $G = 1000$ $G = 1$		1 30 5.3 7.1		$\text{M}\Omega$ $\text{M}\Omega$ $\text{M}\Omega$ $\text{M}\Omega$
OUTPUT						
Output Voltage Swing	V_O	$R_L = 2\text{ k}\Omega; T_A = 25^\circ\text{C}$	± 12.3	± 13.5		V
Output Offset Voltage	V_{OOS}	$T_A = 25^\circ\text{C}$ $T_A = -40^\circ\text{C to } +85^\circ\text{C}$		3 TBD TBD TBD	30	mV $\text{k}\Omega$ $\text{k}\Omega$ pF
Minimum Resistive Load Drive						
Maximum Capacitive Load Drive						
Short Circuit Current Limit	I_{SC}	Output-to-Ground Short		± 50		mA
Output Short Circuit Duration					10	sec
GAIN						
Gain Accuracy	$R_G = \frac{10\text{ k}\Omega}{G-1}$	$T_A = 25^\circ\text{C}$ $R_G = 10\ \Omega, G = 1000$ $R_G = 101\ \Omega, G = 100$ $R_G = 1.1\text{ k}\Omega, G = 10$ $R_G = \infty, G = 1$		0.25 0.20 0.20 0.05		dB dB dB dB
Maximum Gain	G			70		dB
REFERENCE INPUT						
Input Resistance				10		$\text{k}\Omega$
Voltage Range				± 12		V
Gain to Output				1		V/V
POWER SUPPLY						
Supply Voltage Range	V_S		± 5		± 18	V
Supply Current	I_{SY}	$V_{\text{CM}} = 0\text{ V}, R_L = \infty$		± 5.5	± 7.5	mA

Specifications subject to change without notice.

ABSOLUTE MAXIMUM RATINGS

Supply Voltage	±19 V
Input Voltage	Supply Voltage
Output Short Circuit Duration	10 sec
Storage Temperature Range (P, Z Packages)	-65°C to +150°C
Junction Temperature (T _J)	-65°C to +150°C
Lead Temperature Range (Soldering, 60 sec)	300°C
Operating Temperature Range	-40°C to +85°C
Thermal Resistance*	

8-Lead Plastic DIP (P): $\theta_{JA} = 96$; $\theta_{JC} = 37$ °C/W
 16-Lead SOIC (S): $\theta_{JA} = 92$; $\theta_{JC} = 27$ °C/W

* θ_{JA} is specified for worst-case mounting conditions, i.e., θ_{JA} is specified for device in socket for plastic DIP; θ_{JA} is specified for device soldered to printed circuit board for SOL package.

ORDERING GUIDE

Model	Temperature Range	Package Description	Package Option
SSM2019BN	-40°C to +85°C	8-Lead Plastic DIP	N-8
SSM2019BRW	-40°C to +85°C	16-Lead SOIC	RW-16
SSM2019BRWRL	-40°C to +85°C	16-Lead SOIC, reel	RW-16
*SSM2019BRN	-40°C to +85°C	8-Lead SOIC	RN-8
*SSM2019BRNRL	-40°C to +85°C	8-Lead SOIC, reel	RN-8

*For informational purposes only. Marketing should be contacted regarding this package.

CAUTION

ESD (electrostatic discharge) sensitive device. Electrostatic charges as high as 4000 V readily accumulate on the human body and test equipment and can discharge without detection. Although the SSM2019 features proprietary ESD protection circuitry, permanent damage may occur on devices subjected to high-energy electrostatic discharges. Therefore, proper ESD precautions are recommended to avoid performance degradation or loss of functionality.



Typical Performance Characteristics

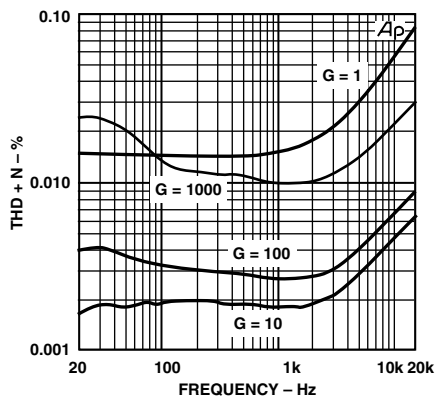

TPC 1. Typical THD + Noise* at $G = 1, 10, 100, 1000$; $V_O = 7 V rms$, $V_S = \pm 15 V$, $R_L = 5 k\Omega$; $T_A = 25^\circ C$

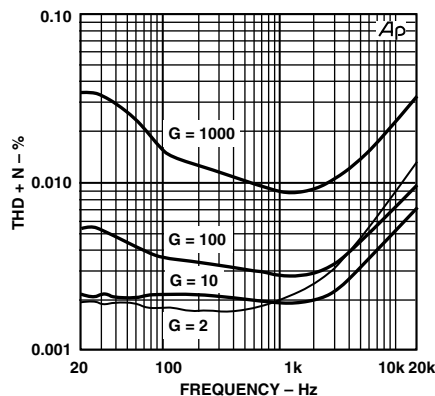

TPC 2. Typical THD + Noise* at $G = 2, 10, 100, 1000$; $V_O = 10 V rms$, $V_S = \pm 18 V$, $R_L = 5 k\Omega$; $T_A = 25^\circ C$

*80 kHz low-pass filter used for TPCs 1 and 2.

SSM2019

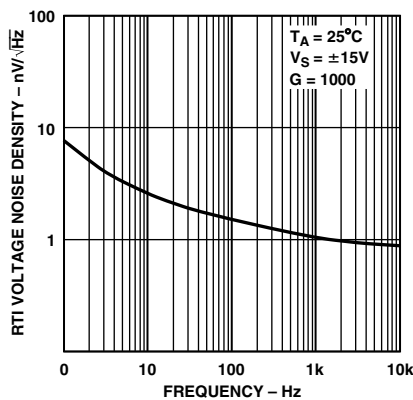

TPC 3. Voltage Noise Density vs. Frequency

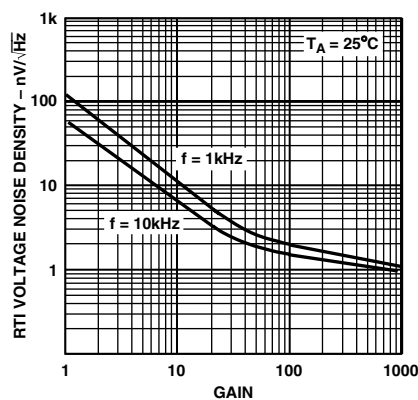

TPC 4. RTI Voltage Noise Density vs. Gain

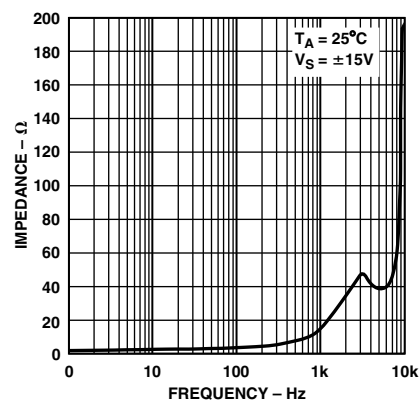

TPC 5. Output Impedance vs. Frequency

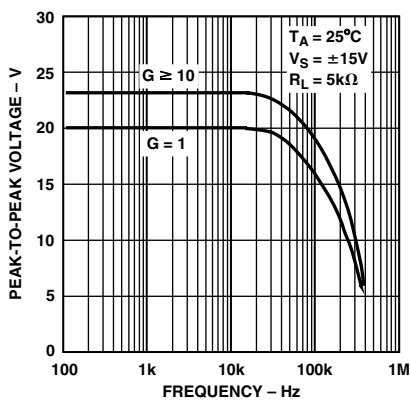

TPC 6. Maximum Output Swing vs. Frequency

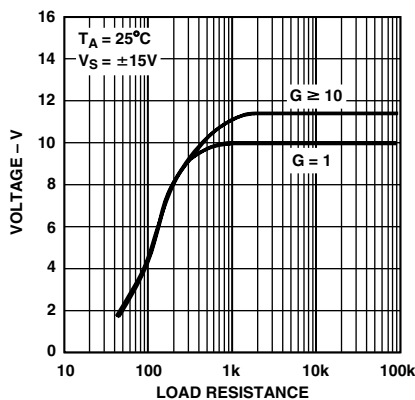

TPC 7. Maximum Output Voltage vs. Load Resistance

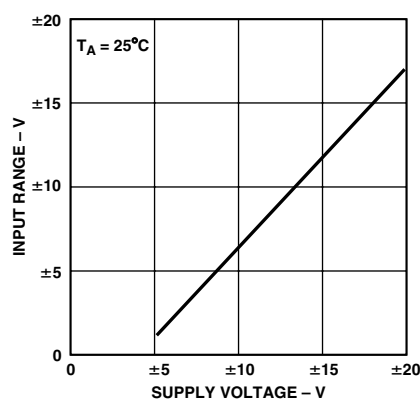

TPC 8. Input Voltage Range vs. Supply Voltage

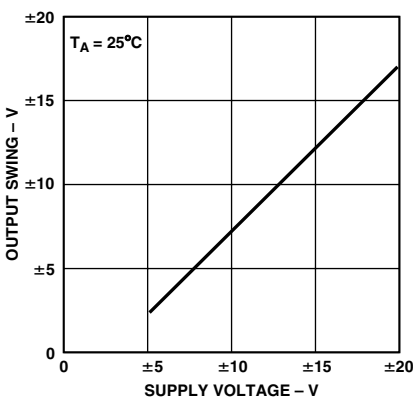

TPC 9. Output Voltage Range vs. Supply Voltage

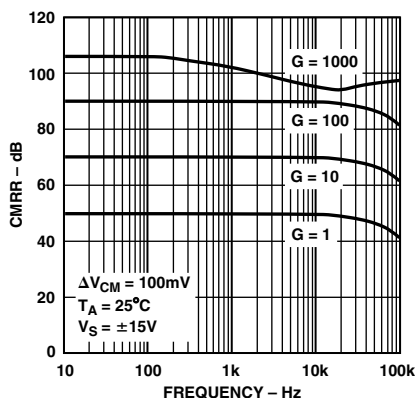

TPC 10. CMRR vs. Frequency

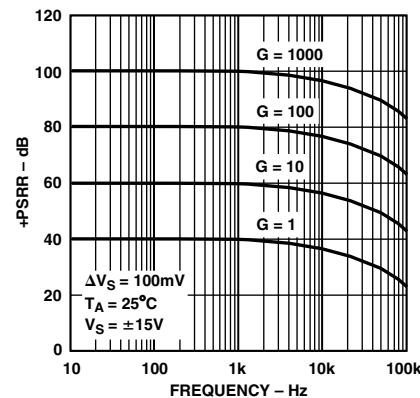

TPC 11. +PSRR vs. Frequency

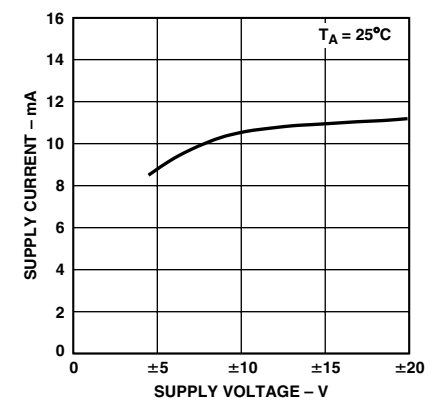
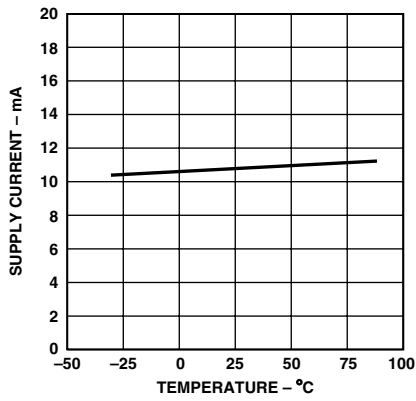
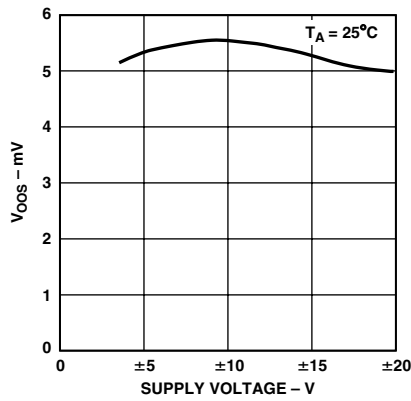
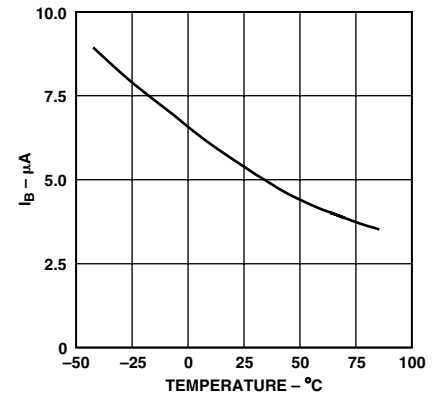
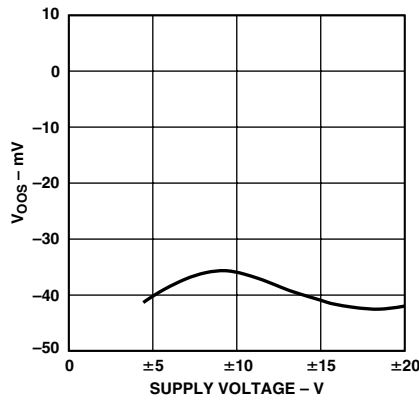
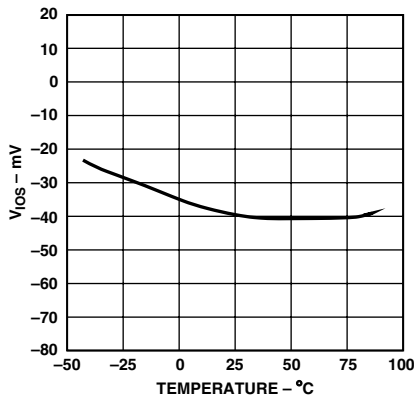
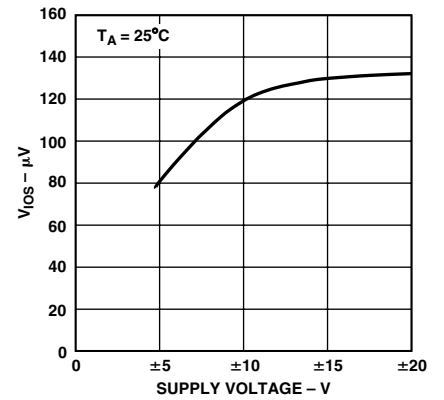
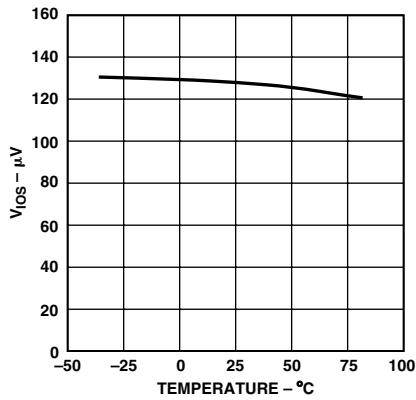
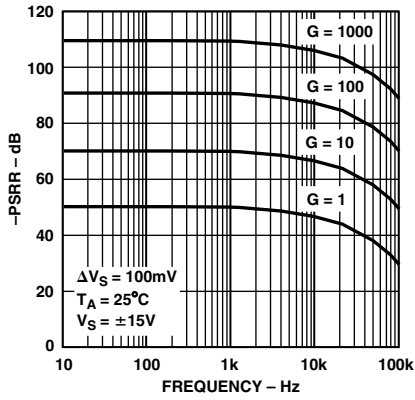

SSM2019

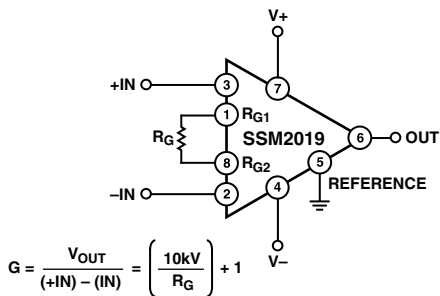

Figure 1. Basic Circuit Connections

GAIN

The SSM2019 only requires a single external resistor to set the voltage gain. The voltage gain, G , is:

$$G = \frac{10\text{ k}\Omega}{R_G} + 1$$

and

$$R_G = \frac{10\text{ k}\Omega}{G - 1}$$

For convenience, Table I lists various values of R_G for common gain levels.

Table I. Values of R_G for Various Gain Levels

A_V	dB	R_G
1	0	NC
3.2	10	4.7 k
10	20	1.1 k
31.3	30	330
100	40	100
314	50	32
1000	60	10

The voltage gain can range from 1 to 3500. A gain set resistor is not required for unity gain applications. Metal-film or wire-wound resistors are recommended for best results.

The total gain accuracy of the SSM2019 is determined by the tolerance of the external gain set resistor, R_G , combined with the gain equation accuracy of the SSM2019. Total gain drift combines the mismatch of the external gain set resistor drift with that of the internal resistors (20 ppm/°C typ).

Bandwidth of the SSM2019 is relatively independent of gain as shown in Figure 2. For a voltage gain of 1000, the SSM2019 has a small-signal bandwidth of 200 kHz. At unity gain, the bandwidth of the SSM2019 exceeds 4 MHz.

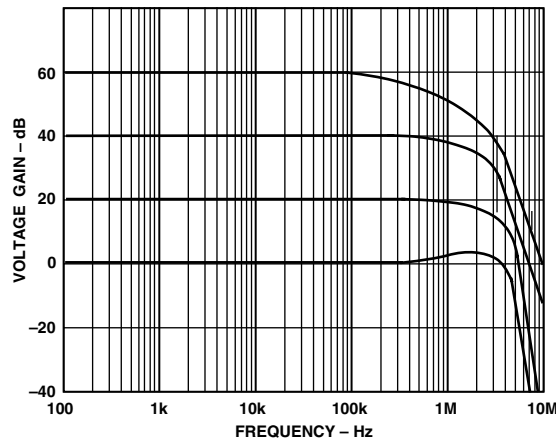

Figure 2. Bandwidth for Various Values of Gain

NOISE PERFORMANCE

The SSM2019 is a very low noise audio preamplifier exhibiting a typical voltage noise density of only 1 nV/√Hz at 1 kHz. The exceptionally low noise characteristics of the SSM2019 are in part achieved by operating the input transistors at high collector currents since the voltage noise is inversely proportional to the square root of the collector current. Current noise, however, is directly proportional to the square root of the collector current. As a result, the outstanding voltage noise performance of the SSM2019 is obtained at the expense of current noise performance. At low preamplifier gains, the effect of the SSM2019's voltage and current noise is insignificant.

The total noise of an audio preamplifier channel can be calculated by:

$$E_n = \sqrt{e_n^2 + (i_n R_S)^2 + e_t^2}$$

where:

E_n = total input referred noise

e_n = amplifier voltage noise

i_n = amplifier current noise

R_S = source resistance

e_t = source resistance thermal noise.

For a microphone preamplifier, using a typical microphone impedance of 150 Ω the total input referred noise is:

$e_n = 1\text{ nV}/\sqrt{\text{Hz}} @ 1\text{ kHz}$, SSM2019 e_n

$i_n = 2\text{ pA}/\sqrt{\text{Hz}} @ 1\text{ kHz}$, SSM2019 i_n

$R_S = 150\ \Omega$, microphone source impedance

$e_t = 1.6\text{ nV}/\sqrt{\text{Hz}} @ 1\text{ kHz}$, microphone thermal noise

$$E_n = \sqrt{(1\text{ nV}/\sqrt{\text{Hz}})^2 + 2(pA/\sqrt{\text{Hz}} \times 150\ \Omega)^2 + (1.6\text{ nV}/\sqrt{\text{Hz}})^2} = 1.93\text{ nV}/\sqrt{\text{Hz}} @ 1\text{ kHz}$$

This total noise is extremely low and makes the SSM2019 virtually transparent to the user.

INPUTS

The SSM2019 has protection diodes across the base emitter junctions of the input transistors. These prevent accidental avalanche breakdown, which could seriously degrade noise performance. Additional clamp diodes are also provided to prevent the inputs from being forced too far beyond the supplies.

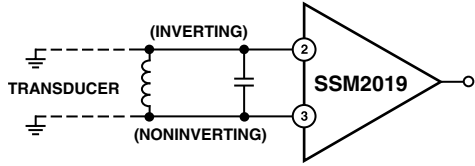

a. Single Ended

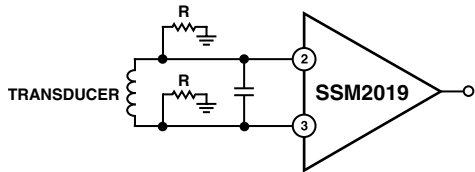

b. Pseudo Differential

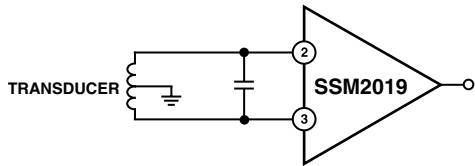

c. True Differential

Figure 3. Three Ways of Interfacing Transducers for High Noise Immunity

Although the SSM2019’s inputs are fully floating, care must be exercised to ensure that both inputs have a dc bias connection capable of maintaining them within the input common-mode range. The usual method of achieving this is to ground one side of the transducer as in Figure 3a. An alternative way is to float the transducer and use two resistors to set the bias point as in Figure 3b. The value of these resistors can be up to 10 kΩ, but they should be kept as small as possible to limit common-mode pickup. Noise contribution by resistors is negligible since it is attenuated by the transducer’s impedance. Balanced transducers give the best noise immunity and interface directly as in Figure 3c.

REFERENCE TERMINAL

The output signal is specified with respect to the reference terminal, which is normally connected to analog ground. The reference may also be used for offset correction or level shifting. A reference source resistance will reduce the common-mode rejection by the ratio of 5 kΩ/R_{REF}. If the reference source resistance is 1 Ω, then the CMR will be reduced to 74 dB (5 kΩ/1 Ω = 74 dB).

COMMON-MODE REJECTION

Ideally, a microphone preamplifier responds only to the difference between the two input signals and rejects common-mode voltages and noise. In practice, there is a small change in output voltage when both inputs experience the same common-mode voltage change; the ratio of these voltages is called the common-mode gain. Common-mode rejection (CMR) is the logarithm of the ratio of differential-mode gain to common-mode gain, expressed in dB.

PHANTOM POWERING

A typical phantom microphone powering circuit is shown in Figure 4. Z₁ through Z₄ provide transient overvoltage protection for the SSM2019 whenever microphones are plugged in or unplugged.

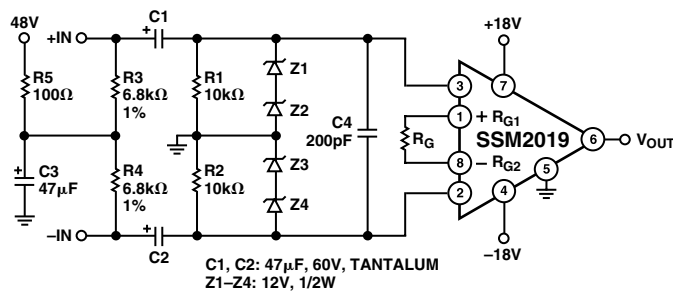

Figure 4. SSM2019 in Phantom Powered Microphone Circuit

SSM2019

BUS SUMMING AMPLIFIER

In addition to its use as a microphone preamplifier, the SSM2019 can be used as a very low noise summing amplifier. Such a circuit is particularly useful when many medium impedance outputs are summed together to produce a high effective noise gain.

The principle of the summing amplifier is to ground the SSM2019 inputs. Under these conditions, Pins 1 and 8 are ac virtual grounds sitting about 0.55 V below ground.

To remove the 0.55 V offset, the circuit of Figure 5 is recommended.

A₂ forms a “servo” amplifier feeding the SSM2019’s inputs. This places Pins 1 and 8 at a true dc virtual ground. R₄ in conjunction with C₂ removes the voltage noise of A₂, and in fact just about any operational amplifier will work well here since it is removed from the signal path. If the dc offset at Pins 1 and 8 is not too critical, then the servo loop can be replaced by the diode biasing scheme of Figure 5. If ac coupling is used throughout, then Pins 2 and 3 may be directly grounded.

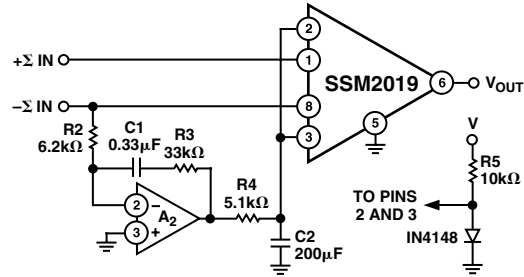
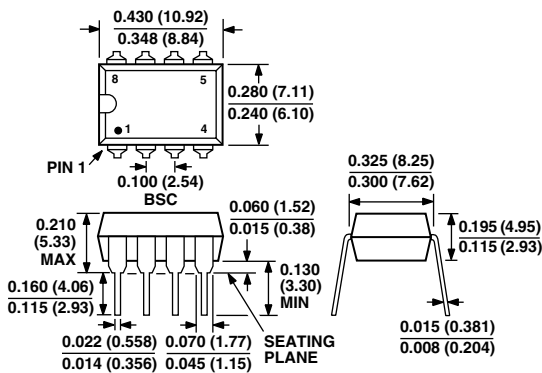

Figure 5. Bus Summing Amplifier

OUTLINE DIMENSIONS

Dimensions shown in inches and (mm).

8-Lead Plastic DIP (N) Package



8-Lead SOIC (RN) Package*

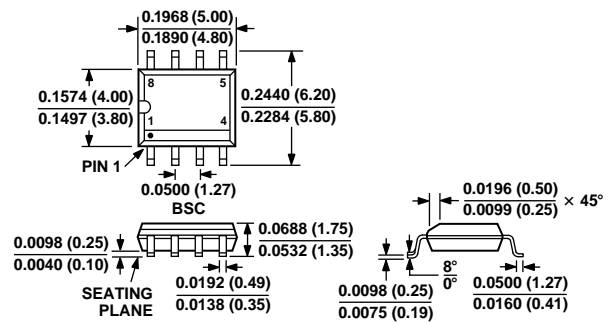

*For informational purposes only. Marketing should be contacted regarding this package.

16-Lead SOIC (RW) Package

