

# International IOR Rectifier

## 30CTQ060 30CTQ060S 30CTQ060 -1

SCHOTTKY RECTIFIER

30 Amp

$$I_{F(AV)} = 30\text{Amp}$$

$$V_R = 50 - 60\text{V}$$

### Major Ratings and Characteristics

Characteristics	30CTQ	Units
$I_{F(AV)}$ Rectangular waveform	30	A
$V_{RRM}$	50 - 60	V
$I_{FSM}$ @ tp = 5 $\mu$ s sine	1000	A
$V_F$ @ 15Apk, $T_J = 125^\circ\text{C}$ (per leg)	0.56	V
$T_J$ range	-55 to 150	$^\circ\text{C}$

### Description/Features

This center tap Schottky rectifier has been optimized for very low forward voltage drop, with moderate leakage. The proprietary barrier technology allows for reliable operation up to 150° C junction temperature. Typical applications are in switching power supplies, converters, free-wheeling diodes, and reverse battery protection.

- 150° C  $T_J$  operation
- Center tap configuration
- Very low forward voltage drop
- High purity, high temperature epoxy encapsulation for enhanced mechanical strength and moisture resistance
- High frequency operation
- Guard ring for enhanced ruggedness and long term reliability

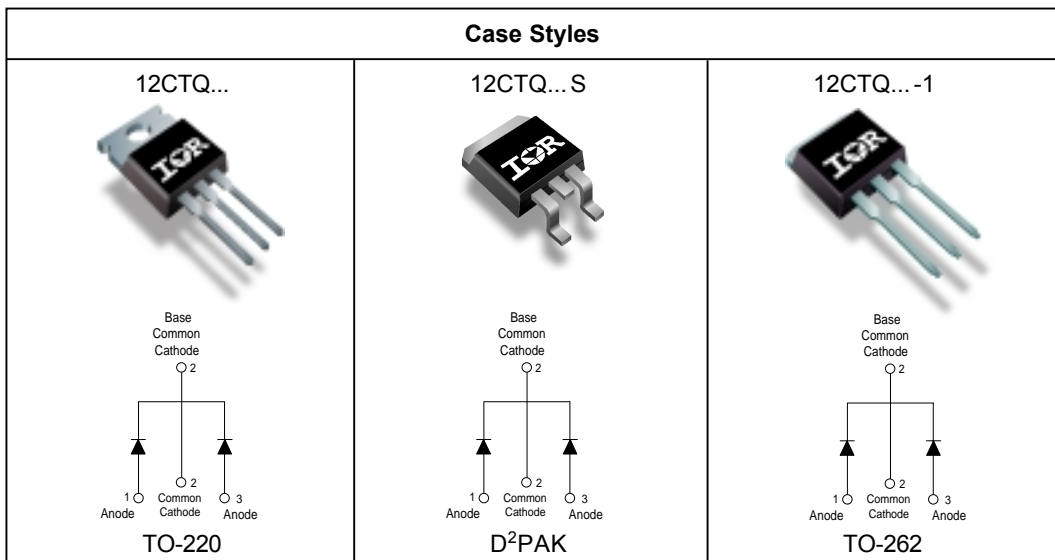

## Voltage Ratings

Partnumber	30CTQ050	30CTQ060
$V_R$ Max. DC Reverse Voltage (V)	50	60
$V_{RWM}$ Max. Working Peak Reverse Voltage (V)		

## Absolute Maximum Ratings

Parameters	Values	Units	Conditions
$I_{F(AV)}$ Max. Average Forward Current (Per Leg) * See Fig. 5 (Per Device)	15	A	50% duty cycle @ $T_C = 105^\circ\text{C}$ , rectangular wave form
	30		
$I_{FSM}$ Max. Peak One Cycle Non-Repetitive Surge Current (Per Leg) * See Fig. 7	1000	A	5 $\mu\text{s}$ Sine or 3 $\mu\text{s}$ Rect. pulse
	260		10ms Sine or 6ms Rect. pulse
$E_{AS}$ Non-Repetitive Avalanche Energy (Per Leg)	13	mJ	$T_J = 25^\circ\text{C}$ , $I_{AS} = 1.50$ Amps, $L = 11.5$ mH
$I_{AR}$ Repetitive Avalanche Current (Per Leg)	1.50	A	Current decaying linearly to zero in 1 $\mu\text{sec}$ Frequency limited by $T_J$ max. $V_A = 1.5 \times V_R$ typical

## Electrical Specifications

Parameters	Values	Units	Conditions
$V_{FM}$ Max. Forward Voltage Drop (Per Leg) * See Fig. 1 (1)	0.62	V	@ 15A
	0.82	V	@ 30A
	0.56	V	@ 15A
	0.71	V	@ 30A
$I_{RM}$ Max. Reverse Leakage Current (Per Leg) * See Fig. 2 (1)	0.80	mA	$T_J = 25^\circ\text{C}$
	45	mA	$T_J = 125^\circ\text{C}$
$V_{F(TO)}$ Threshold Voltage	0.39	V	$T_J = T_J$ max.
$r_t$ Forward Slope Resistance	8.47	m $\Omega$	
$C_T$ Max. Junction Capacitance (Per Leg)	720	pF	$V_R = 5V_{DC}$ , (test signal range 100Khz to 1Mhz) $25^\circ\text{C}$
$L_S$ Typical Series Inductance (Per Leg)	8.0	nH	Measured lead to lead 5mm from package body
dv/dt Max. Voltage Rate of Change (Rated $V_R$ )	10000	V/ $\mu\text{s}$	

(1) Pulse Width < 300 $\mu\text{s}$ , Duty Cycle <2%

## Thermal-Mechanical Specifications

Parameters	Values	Units	Conditions
$T_J$ Max. Junction Temperature Range	-55 to 150	$^\circ\text{C}$	
$T_{stg}$ Max. Storage Temperature Range	-55 to 150	$^\circ\text{C}$	
$R_{thJC}$ Max. Thermal Resistance Junction to Case (Per Leg)	3.25	$^\circ\text{C}/\text{W}$	DC operation
$R_{thJC}$ Max. Thermal Resistance Junction to Case (Per Package)	1.63	$^\circ\text{C}/\text{W}$	DC operation
$R_{thCS}$ Typical Thermal Resistance, Case to Heatsink	0.50	$^\circ\text{C}/\text{W}$	Mounting surface, smooth and greased (only for TO-220)
wt Approximate Weight	2(0.07)	g(oz.)	
T Mounting Torque	Min.	6(5)	Kg-cm (lbf-in)
	Max.	12(10)	

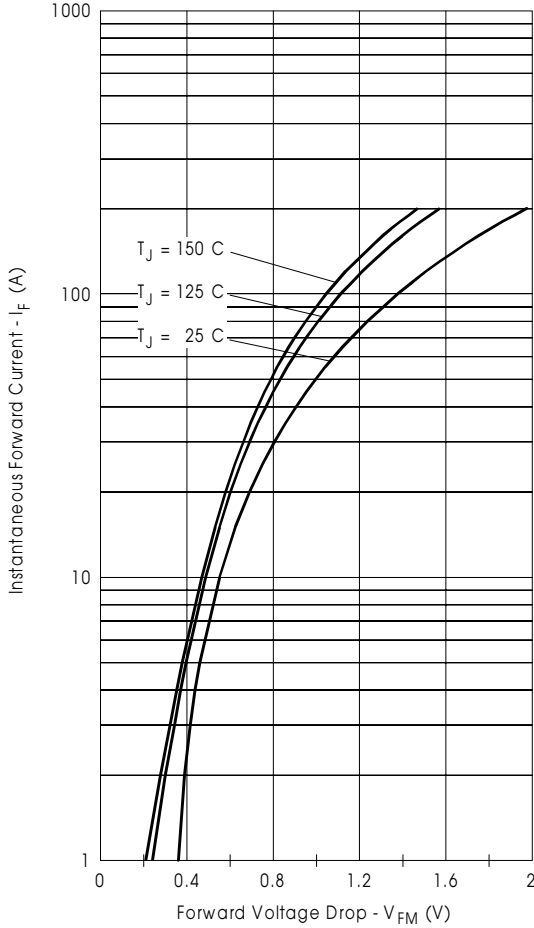

Fig. 1 - Max. Forward Voltage Drop Characteristics (PerLeg)

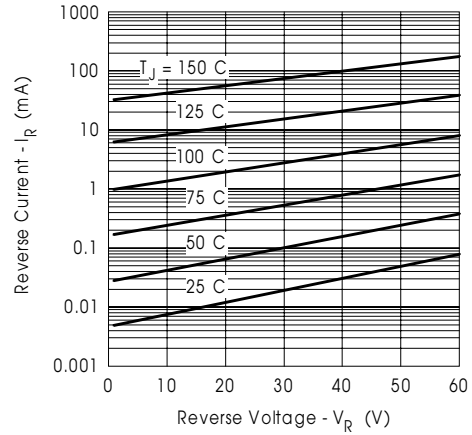

Fig. 2 - Typical Values Of Reverse Current Vs. Reverse Voltage (PerLeg)

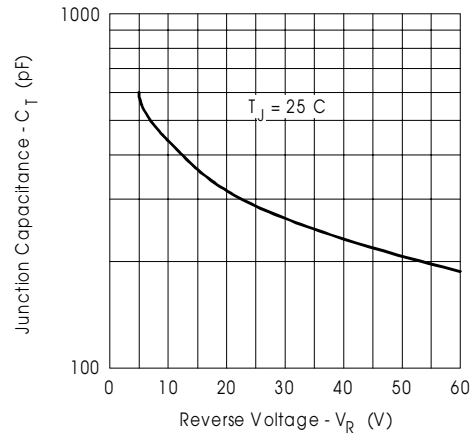

Fig. 3 - Typical Junction Capacitance Vs. Reverse Voltage (PerLeg)

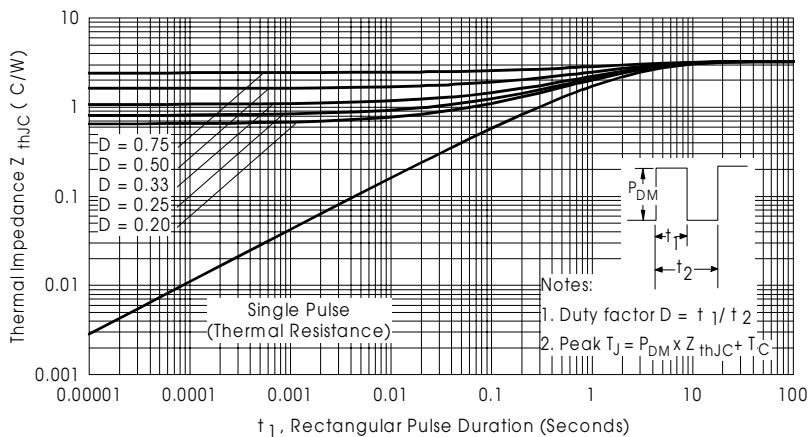

Fig. 4 - Max. Thermal Impedance  $Z_{thJC}$  Characteristics (PerLeg)

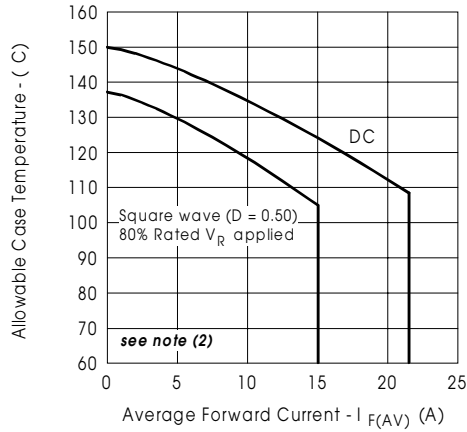

Fig. 5 - Max. Allowable Case Temperature Vs. Average Forward Current (Per Leg)

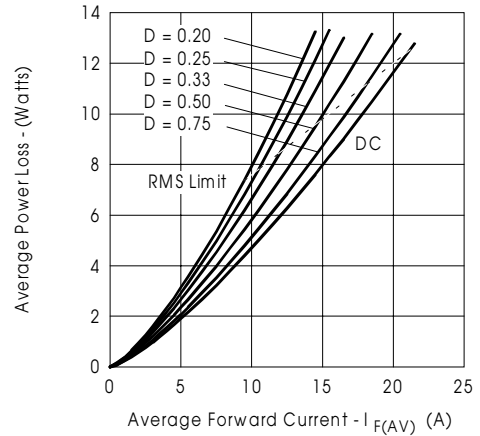

Fig. 6 - Forward Power Loss Characteristics (Per Leg)

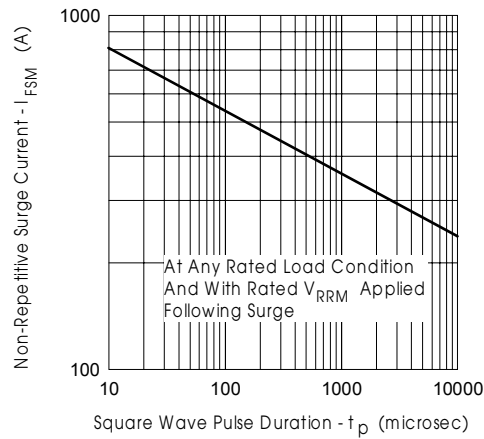

Fig. 7 - Max. Non-Repetitive Surge Current (Per Leg)

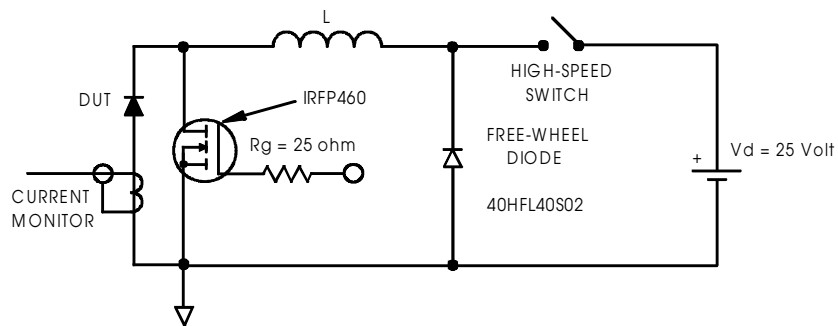

Fig. 8 - Unclamped Inductive Test Circuit

(2) Formula used:  $T_C = T_J - (P_d + P_{d_{REV}}) \times R_{thJC}$ ;

$P_d = \text{Forward Power Loss} = I_{F(AV)} \times V_{FM} @ (I_{F(AV)} / D)$  (see Fig. 6);

$P_{d_{REV}} = \text{Inverse Power Loss} = V_{R1} \times I_R (1 - D); I_R @ V_{R1} = 10 \text{ V}$

Outline Table

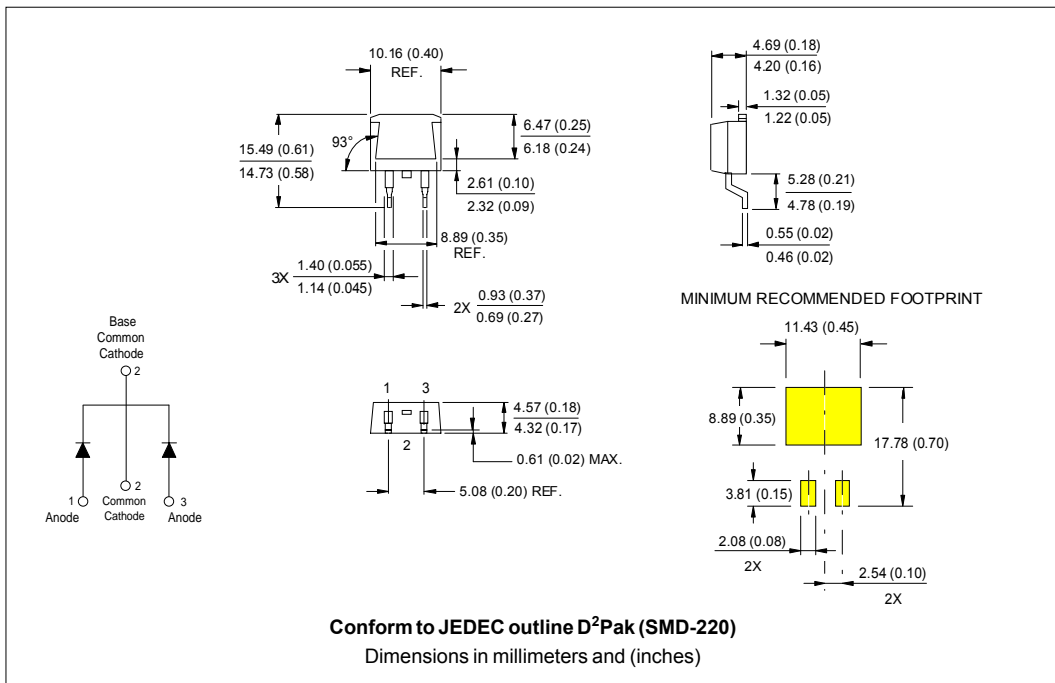
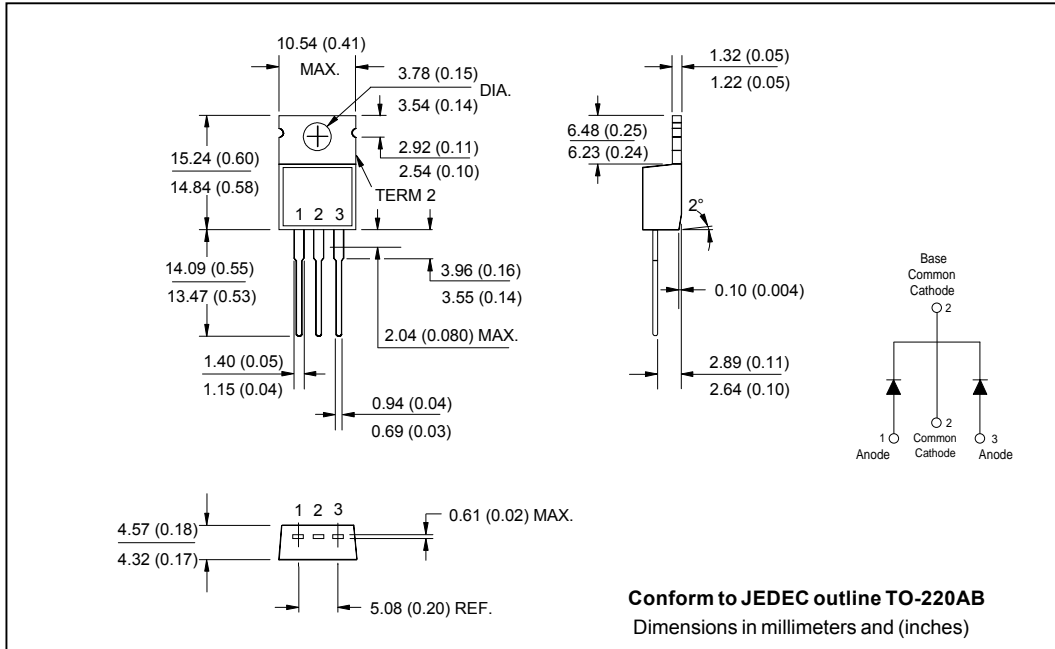

Outline Table

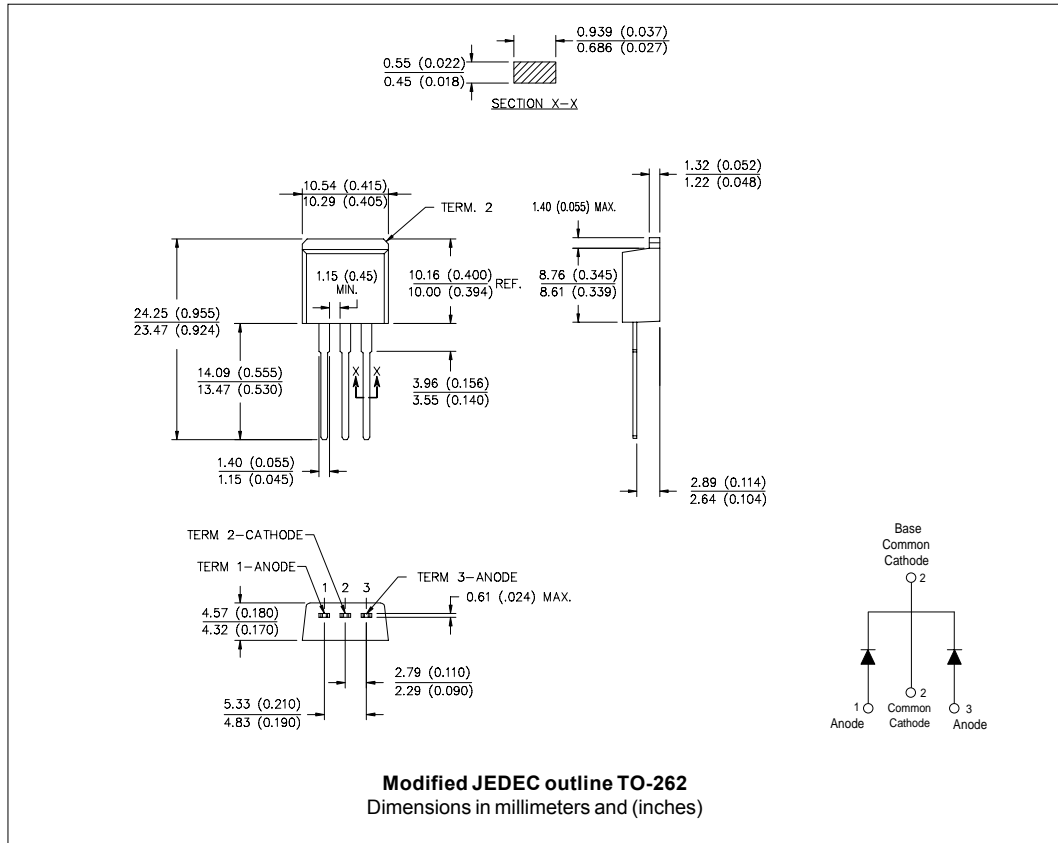

Marking Information

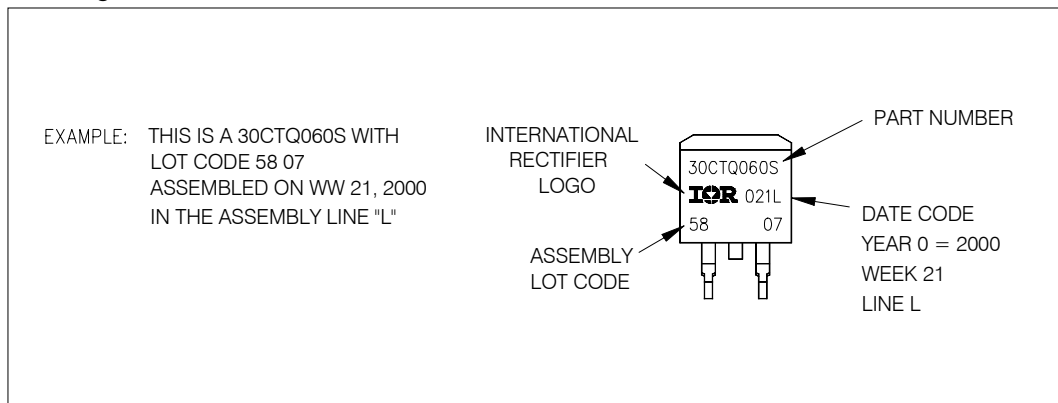

Tape & Reel Information

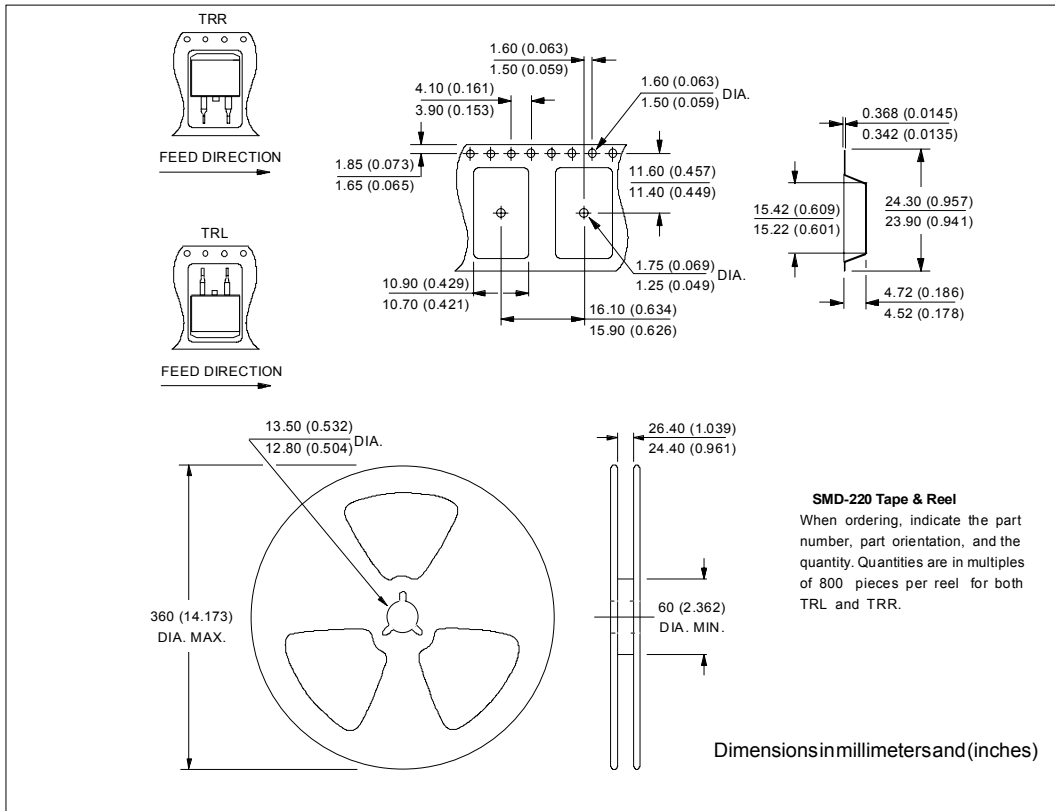

Ordering Information Table

Device Code					
30	C	T	Q	060	-1
①	②	③	④	⑤	⑥
<b>1</b>	- Essential Part Number				
<b>2</b>	- C = Common Cathode				
<b>3</b>	- T = TO-220				
<b>4</b>	- Q = Schottky Q Series				
<b>5</b>	- Voltage Rating				050 = 50V
<b>6</b>	- 1 = TO-262				060 = 60V
	- S = D <sup>2</sup> Pak				

## 30CTQ... Series

Bulletin PD-20300 rev. A 10/01

International  
**IOR** Rectifier

---

Data and specifications subject to change without notice.  
This product has been designed and qualified for Industrial Level.  
Qualification Standards can be found on IR's Web site.

International  
**IOR** Rectifier

**IR WORLD HEADQUARTERS:** 233 Kansas St., El Segundo, California 90245, USA Tel: (310) 252-7105

TAC Fax: (310) 252-7309

Visit us at [www.irf.com](http://www.irf.com) for sales contact information. 10/01